



# MR150 Man Rider<sup>®</sup> Winch

150 kg (330 lb)



Ideal for:



Onshore



Offshore



Subsea

# MR150 Man Rider® Winch

150 kg (330 lb)



Since 1924, Ingersoll Rand has been building extremely durable and reliable hoists and winches. Designed to work in harsh environments and built using rugged steel and stainless steel Ingersoll Rand doesn't take shortcuts and never uses inferior components. Ingersoll Rand MR150 Man Rider winches are specifically designed to minimize the risks of lifting people. They meet or exceed strict safe-lifting standards and include features like emergency lowering, slack line detection and redundant braking systems to help ensure the safety of workers. Ingersoll Rand pioneered the development of Man Rider winches and has provided thousands of them to drilling companies

around the world in the most extreme environments. This experience is built into every Man Rider winch we sell. Trust Ingersoll Rand MR150 Man Rider winches to help you protect your most important asset, your people.

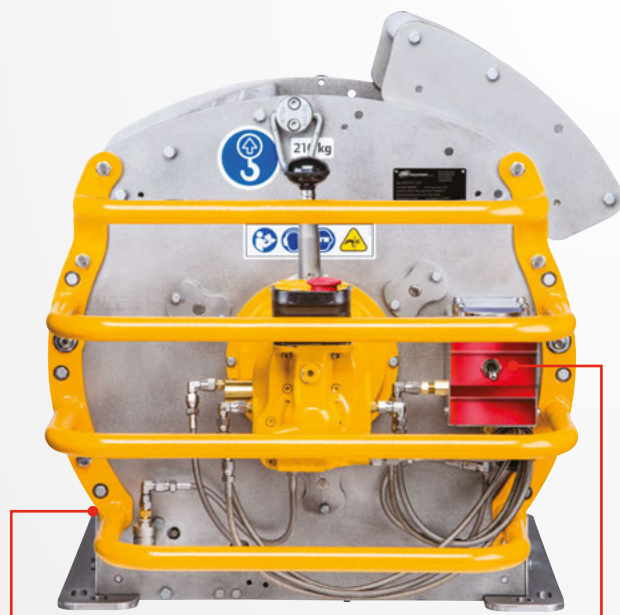

**Automatic Multi-Disc Brake and Automatic Drum Brake** provide the safety of redundant braking systems

**Emergency Lowering System** standard integrated system lowers a rider in case of power failure

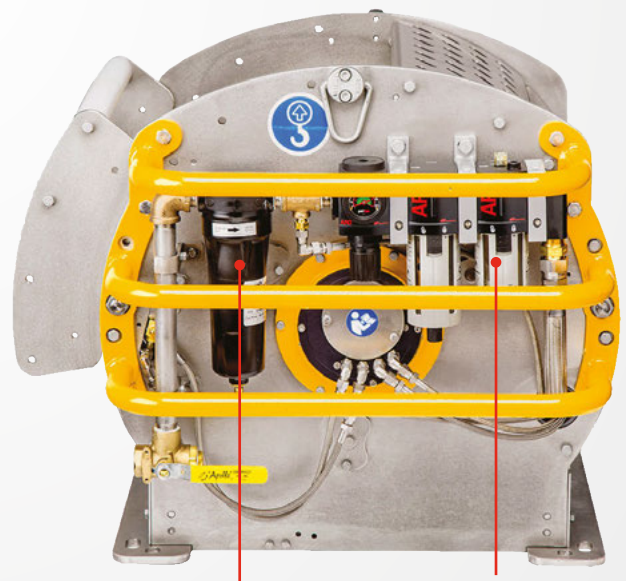

**Integrated Water Separator** helps protect the motor from moisture

**Integrated Filter, Regulator and Lubricator** provide clean air to extend the winch's operational life

# Designed for Performance in Any Environment

## MR150 Man Rider® Standard Features

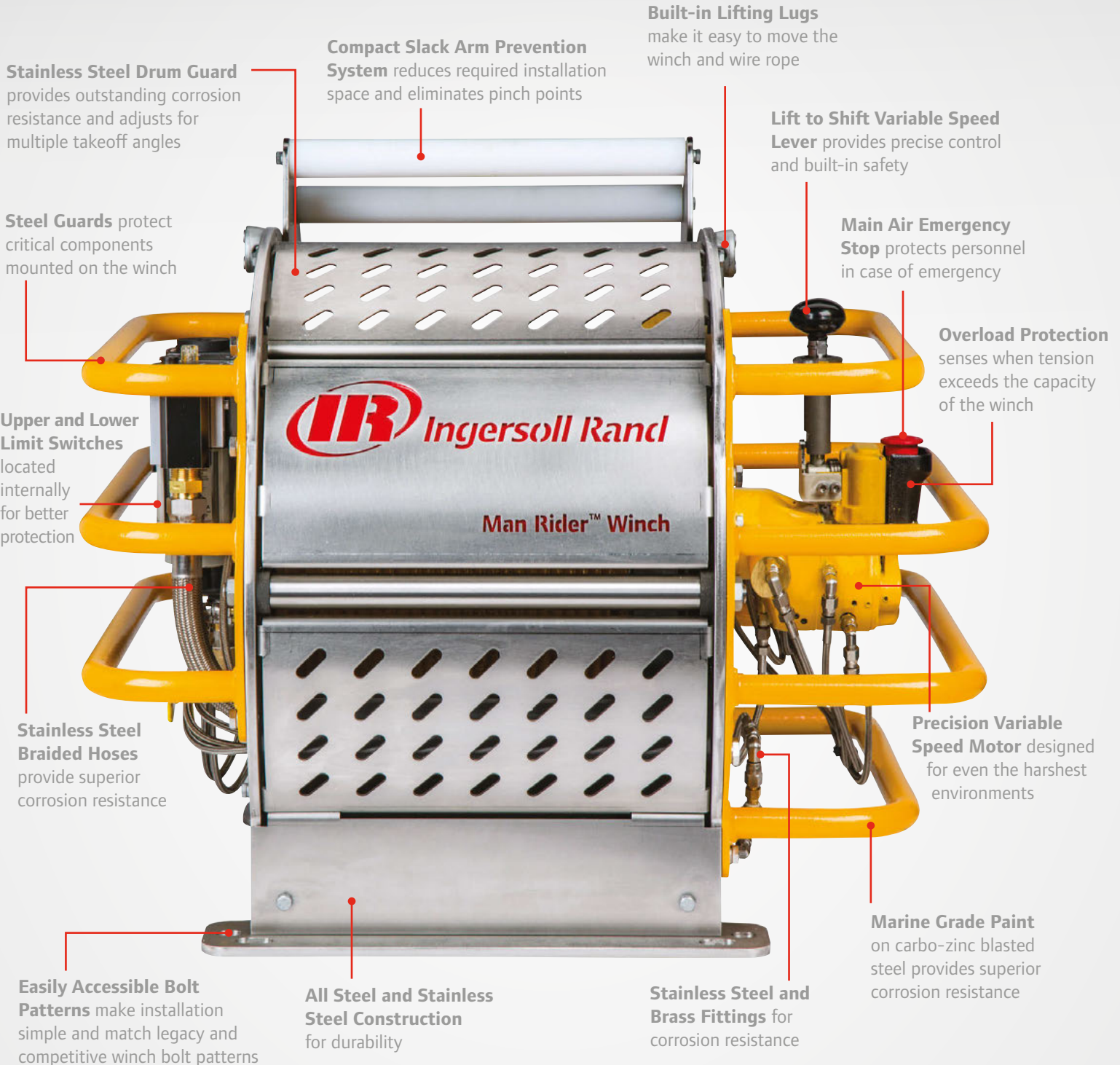

## Built with Experience You Can Trust



Ingersoll Rand MR150 Man Rider® winches leverage the solid foundation of our legacy Man Rider lines and incorporate additional features to provide an extremely safe and durable products. They are built to survive where other winches cannot. The MR150 Man Rider has a stainless steel frame and drum guard for enhanced corrosion resistance. All the fittings are brass and stainless steel and hoses are made from braided stainless steel to provide the long lasting durability you need. MR150 Man Rider winches help protect operators and riders with dual braking systems, internal upper and lower

limit switches, an integrated emergency lowering system, and slack line detection system. Designed to meet the latest regulations including CE and ATEX and available with ABS and DNV type approvals, Ingersoll Rand Man Rider winches work wherever you do. Built with our decades of experience, count on Ingersoll Rand MR150 Man Rider winches wherever you need to lift or lower people.

## The Importance of Using a Man Rider® Winch

**Why should you use an Ingersoll Rand Man Rider® Winch instead of a standard winch to lift and lower people on an oil rig?** In one word, safety. Deaths and serious injuries caused by falls are common in the oil and gas industry. The numbers speak for themselves:

- 186 lost time or disabling falls to lower levels in the Alberta, Canada upstream oil and gas industry.<sup>1</sup>
- 7% of US<sup>2</sup> and 9% of Middle East/African<sup>3</sup> oil worker fatalities caused by falls from higher to lower levels.
- 41 serious injuries attributed to falls from height with 1 fatality in the North Sea.<sup>4</sup>



Ingersoll Rand Man Rider winches provide safety features that greatly reduce the risk of these types of incidents. From integrated limit switches that prevent raising or lowering a person past a safe point, to dual braking systems, to a slack arm prevention system that automatically stops wire rope from being paid out in case of obstruction that reduces the risk of accidental fall, Ingersoll Rand Man Rider winches combine all the features you need to comply with onshore and offshore regulations for personnel lifting. But even more importantly, Ingersoll Rand Man Rider winches help protect the one piece of critical equipment on your rig that can never be replaced – your people.

<sup>1</sup> Occupational Injuries and Diseases in Alberta 2010, Worksafe Alberta

<sup>2</sup> U.S. Centers for Disease Control, 2003-2006

<sup>3</sup> International Association of Oil & Gas Producers, 2009

<sup>4</sup> Annual Offshore Statistics, UK Health and Safety Executive, 2014

## MR150 Aftermarket Parts And Service Support

In the challenging environments where Ingersoll Rand Man Rider MR150 winches are used, maintenance and serviceability are critical to maximum uptime. That's why the MR150 Man Rider winch was designed to be easy to service and repair. The MR150 Man Rider winch features interchangeable panels, easily accessible components and an Aftermarket Support organization ready to support you with a range of services and readily available spare parts. Ingersoll Rand helps to keep your investment operating with the following services:

### EnCompass Service Program –

EnCompass Man Rider Authorized Service Centers are specially trained and qualified service centers that provide EnCompass Inspections and EnCompass Service & Certifications to ensure your Man Rider winch is in premium condition and certified for safe operation.



**Aftermarket Spare Parts Offering** – Ingersoll Rand provides a complete offering of spare parts and service kits to assist in the rapid repair or refurbishment of your Man Rider winch.

**Service Guidance** – Ingersoll Rand takes the guess-work out of servicing and repairing your Man Rider winches with easy-to-use service interval guides that help you keep your MR150 Man Rider winch operating at peak performance.

**Training** – Man Rider winches are critical pieces of equipment that get used every day. Ingersoll Rand provides training in proper use and maintenance to help keep your operation running efficiently and your people safe.

## Global Parts and Services

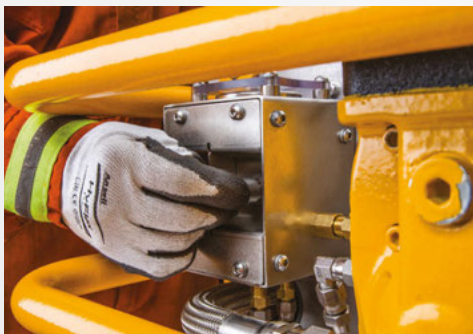

Ingersoll Rand winches are built to last in even the harshest conditions. We are committed to helping you keep your operation running, no matter where your facility is located. We offer a full range of parts and accessories. Plus Ingersoll Rand's global network of factory trained and authorized technicians can install, repair, test and maintain any winch. Service capabilities include:

- Load test and recertifications
- Installation and start-up assistance
- System inspections
- Inspector and operator training
- Equipment refurbishments
- Service and repair

# A Tradition of Proven Reliability, Efficiency and Productivity



No matter where you are located, Ingersoll Rand is committed to serving and providing you with the necessary information with regard to our products and services. Our world-wide network of distributors, certified technicians and engineers are a telephone call away — ready to support you with innovative and cost-effective solutions that will keep your business running at peak performance.

## Special Orders

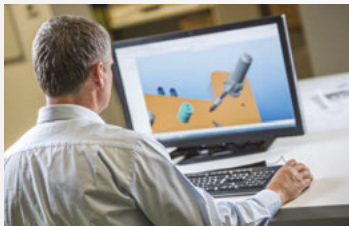

Ingersoll Rand can provide customized solutions for your application. Whether you need to move specialized or high capacity loads or have custom control requirements, we can build the right solution for you. Ingersoll Rand's global account management team, dedicated project managers and engineering teams are focused exclusively on high capacity hoists and winches. From evaluation to installation and beyond, contact us to build your custom solution today.

- Design for custom capacities
- Custom control systems
- Custom product modifications
- Witness testing and complete certification to any global standard
- Full engineering capabilities including data packages and CAD drawings
- Global Account Management and dedicated project management teams
- Onsite services available including presale evaluation, installation and maintenance

## For More Information



[www.ingersollrandproducts.com/ManRider](http://www.ingersollrandproducts.com/ManRider)



[lifting@irco.com](mailto:lifting@irco.com)

# Performance and Dimensions

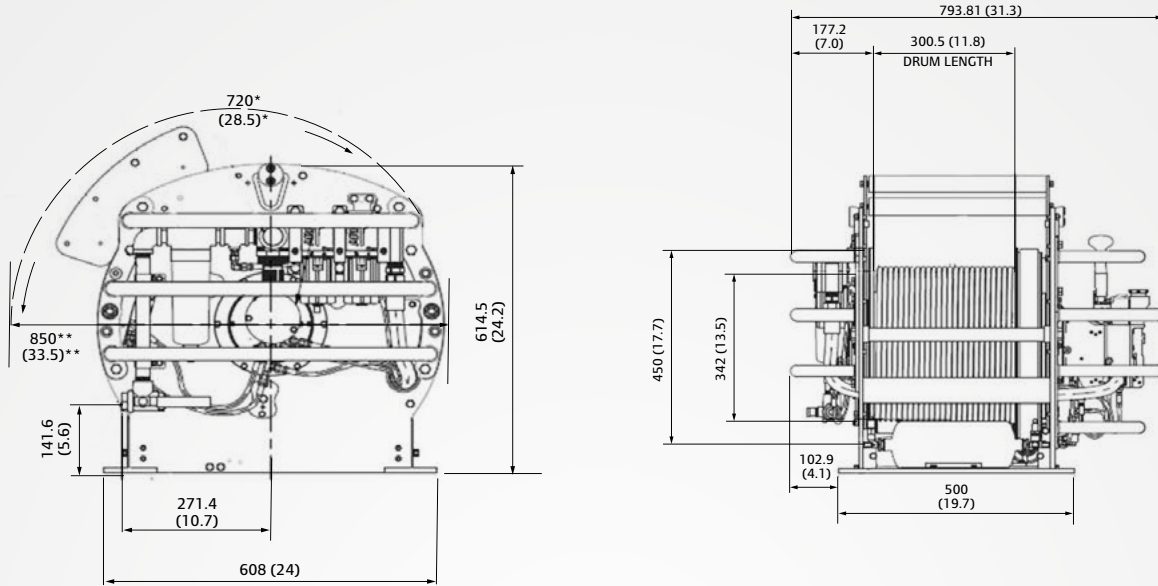

\* Maximum radius of Slack Arm Prevention System  
 \*\* Maximum depth with Slack Arm Prevention System in lowest position

Dimensions shown in mm and (in). Standard bolt pattern is compatible with Ingersoll Rand FA150, LS150 and LS2150 winches.

General Performance and Characteristics at 90 psi (6.2 bar) inlet pressure							
Motor Type	Rated Capacity at Top Layer	Line Speed	Max. Rope Storage Capacity	Working Rope Capacity	Drum Length	Air Consumption with Rated Load	Net Weight
	kg (lb)	m/min (fpm)	(w/10 mm rope) m (ft)	(w/10 mm rope) m (ft)	mm (in)	m <sup>3</sup> /min (ft <sup>3</sup> /min)	kg (lb)
MR150K Gear Air Motor	150 (330)	30 (98)	180 (591)	55 (180)	300 (11.8)	2.5 (88)	210 (465)

## How to Order

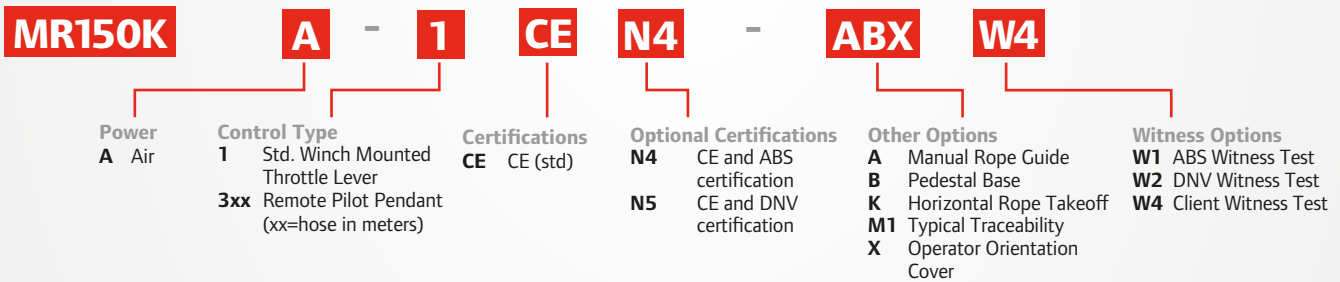

## A Variety of Options



**Remote Pilot Pendant**  
 Ergonomic pilot pendant provides remote raising, lowering and emergency stop features.

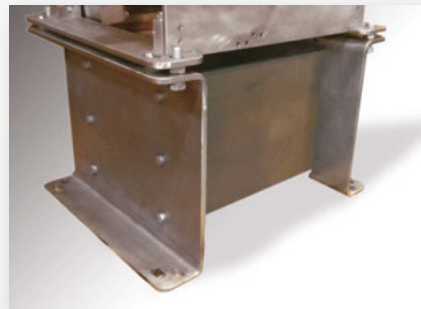

**Pedestal Base**  
 Raises the MR150 off the rig floor. Includes pre-drilled bolt holes which match our legacy Man Rider and competitive products for securing to the rig floor.



**Certification and Witness Options**  
 Certifications and witness testing options to meet the latest regulations from ABS, DNV and others are available.



Ingersoll Rand (NYSE:IR) advances the quality of life by creating comfortable, sustainable and efficient environments. Our people and our family of brands—including Club Car®, Ingersoll Rand®, Thermo King® and Trane®—work together to enhance the quality and comfort of air in homes and buildings; transport and protect food and perishables; and increase industrial productivity and efficiency. We are a \$12 billion global business committed to a world of sustainable progress and enduring results.



[www.ingersollrandproducts.com](http://www.ingersollrandproducts.com)

Distributed by:

Ingersoll Rand, IR, the IR logo are trademarks of Ingersoll Rand, its subsidiaries and/or affiliates. All other trademarks are the property of their respective owners.

Unless otherwise noted this equipment is not designed for transporting people or lifting loads over people. It is the user's responsibility to determine the suitability of this product for any particular use and to check compliance with applicable regulations. Before installation, see maintenance and operations manual for additional warnings and precautions.

Nothing contained on these pages is intended to extend any warranty or representation, expressed or implied, regarding the product described herein. Any such warranties or other terms and conditions of sale of products shall be in accordance with Ingersoll Rand's standard terms and conditions of sale for such products, which are available upon request.

Product improvement is a continuing goal at Ingersoll Rand. Designs and specifications are subject to change without notice or obligation.