

MSG® TURBO-AIR® NX Centrifugal Compressed Air System

300-4,200 kW (400-5,650 hp)



YOUR TRUSTED PARTNER IN COMPRESSED AIR

Staying ahead of your competition with advanced compressed air systems and services that boost productivity, lower operating expenses and extend equipment life is critical to your success.

No matter the industry or application, you can count on Ingersoll Rand® as a trusted partner for centrifugal compressed air technologies and services. By focusing on you and your business, we provide collaborative solutions that make you successful, offering a total systems approach to maximize efficiency and performance.

Take a Systems Approach

Delivering reliable compressed air to your facility goes well beyond the compressor itself. Optimize total cost of ownership (TCO) through a systems approach that employs the best air compression technologies to deliver reliability for life—from design to decommissioning.

Your business will benefit from Ingersoll Rand's partnership through our extensive experience and global expertise to ensure reliability, lower maintenance costs, ease of serviceability and system optimization.

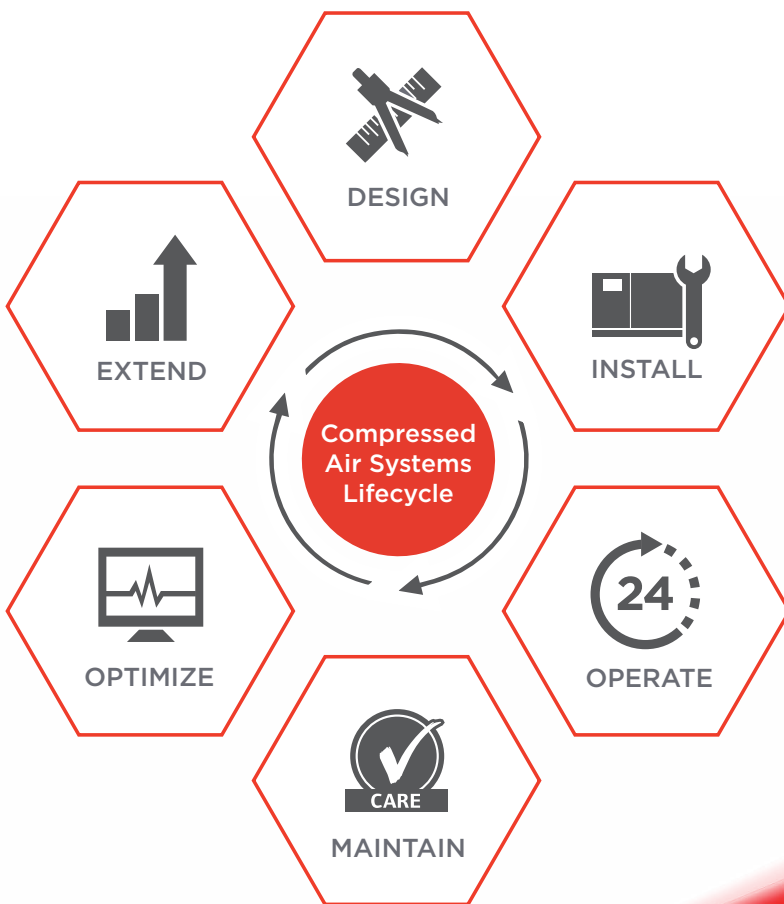





Let's Get Started Together

Throughout the entire lifecycle, our systems approach helps you achieve the lowest operating cost.



PURELY EFFICIENT CENTRIFUGAL TECHNOLOGY

Integrally geared centrifugal compressors represent the latest technology, offering significant advantages over outdated, less-efficient and more costly compressor designs. Compare the innovative technology of the MSG® TURBO-AIR® NX with other compressors, and the advantages are clear.

MSG TURBO-AIR COMPRESSORS		OTHER COMPRESSORS
<ul style="list-style-type: none"> • Compression elements do not wear or require periodic replacement • Oil filter elements are easily replaced • Bearings designed for extended life 	LOW MAINTENANCE 	<ul style="list-style-type: none"> • Require regular maintenance and periodic replacement of airends • Result in high operating expenses and significant machine downtime
<ul style="list-style-type: none"> • 100% oil-free per ISO 8573-1 certification • Prevent contamination of system 	OIL-FREE AIR 	<ul style="list-style-type: none"> • Oil filters must be installed at discharge • Potential for oil carryover that fouls the process
<ul style="list-style-type: none"> • Centrifugal compressors are proven to have a long meantime between failures (MTBF), and independent research has shown an industry-leading availability of 99.7% • Conservative high-quality gear design 	RELIABILITY 	<ul style="list-style-type: none"> • Contacting compression elements are subject to wear • Limited rotating element life • Designed-in wearing items to generate aftermarket revenues
<ul style="list-style-type: none"> • Automatic operation for any operating condition • State-of-the-art MAESTRO™ suite of controls • PLC control available 	OPTIMUM CONTROL 	<ul style="list-style-type: none"> • Limited control capability • Costly, high-maintenance variable speed configurations
<ul style="list-style-type: none"> • Essentially vibration-free • No special foundation is required 	NO VIBRATION 	<ul style="list-style-type: none"> • Special foundations needed to handle heavy weight • Precautions must be taken to prevent transmission of vibration to other equipment

Centrifugal Compressors Designed for Your Application

We offer a broad portfolio of reliable centrifugal products that will adapt to your application. With more than 40,000 centrifugal installations worldwide, on nearly every continent, Ingersoll Rand's products are proven in a number of different industries.



Food & Beverage

Minimize the risk for product contamination and spoilage



Textile

High-tech air jet looms require super clean 100% oil-free air



Oil & Gas

Robust centrifugal systems that meet API standards



Aerospace

Proven design to meet demanding manufacturing environments



Chemical

Achieve the highest purity to minimize risk of product liability

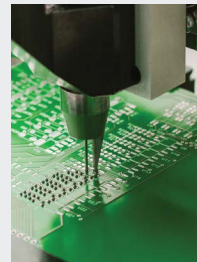

Electronics

Eliminate wet or oily compressed air that causes downtime

AIR COMPRESSORS

With experienced design teams, ISO certified management systems and comprehensive product testing for aerodynamic and mechanical performance, our MSG TURBO-AIR NX centrifugal compressors provide the performance and quality that you need.



The Right Compressor for Your Operation

MSG TURBO-AIR NX centrifugal compressors are completely packaged on a common base to reduce footprint and are available in a number of configurations to meet your system requirements.

See Our Entire Centrifugal Portfolio

What Makes Our MSG TURBO-AIR NX Centrifugal Compressors Unique?

Efficient Design



Highly efficient aerodynamic components combine with low mechanical losses and power conserving IGV to provide up to 5% better specific power than competitive models.

Robust Reliability

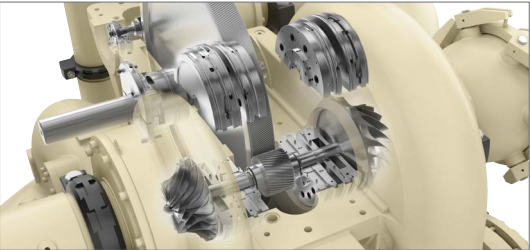

Industry-leading reliable design with time-tested split pinion bearings, AGMA 13 gearing, a robust thrust management system and stainless steel compression elements.

Intuitive Control



MAESTRO controllers include a web server and USB port, can monitor and control multiple units, and will integrate with on-site host systems to optimize performance.

Less Downtime



Our compressors are designed to simplify installation and maintenance, including a single-point electrical connection, a horizontally split gearbox and cleanable in-place cooler bundles.

AIR COMPRESSORS

See The Difference

At the heart of every MSG TURBO-AIR NX compressor is the time-tested, field inspectable, split pinion bearing and seal design, always validated with extensive operational testing. Standard gearbox covers allow you to quickly and easily look inside the compressor for periodic review and assessment of the gear conditions.

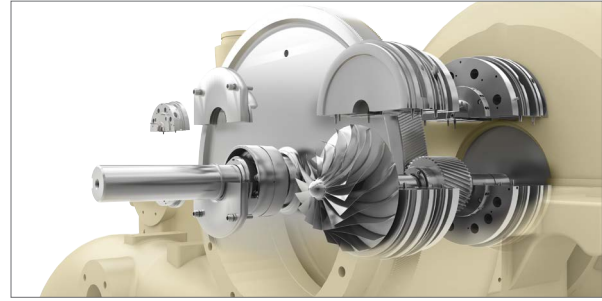

MSG TURBO-AIR NX 8000 Augmented Reality Tour

World-Class Drive Motors

The drive motor for our MSG TURBO-AIR NX compressors can be designed to meet your specific site requirements. This includes options like API/hazardous duty operation, special enclosure types and IE-class high efficiency models.

Operational Flexibility

With a turndown range that typically exceeds 30%, MSG TURBO-AIR NX compressors can be used in a wider variety of demand scenarios without the need to unload or shut down during periods of low compressed air demand. The standard inlet guide vane allows the compressor to be cost-effectively throttled down to match the demand flow anywhere along the curve.

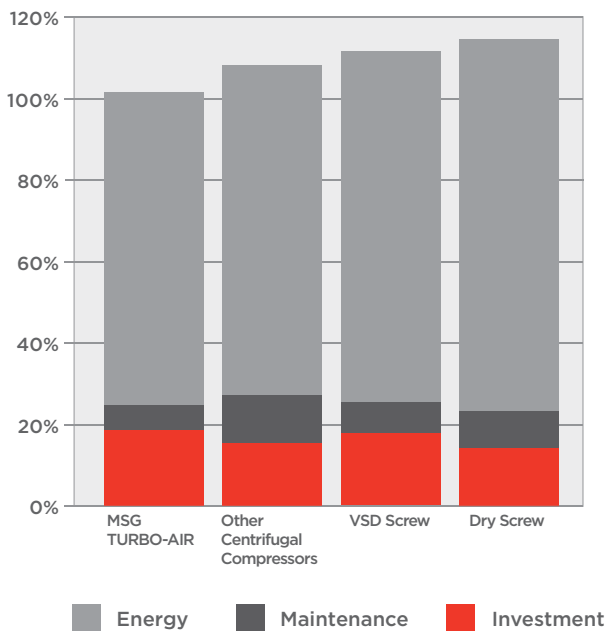
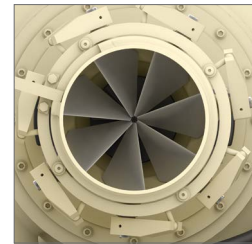

Low Total Cost of Ownership

Over time, the energy required to power a compressed air system is the largest cost associated with a compressor; particularly in today's fluctuating energy markets. That is why, to accurately determine the return on your investment, it is important to consider the total life-cycle cost of operating the compressor, including the initial investment, energy consumption and maintenance costs.

A System of Unprecedented Innovation

The MSG TURBO-AIR NX 2500 and NX 5000 offer best-in-class efficiency, maximum uptime and hassle-free, low-cost installation, operation and maintenance. The complete package offers a number of innovations that are standard, along with options that can be customized for your specific operation.

Cooling System

- Straight 3/8" (5/8" optional) copper tube design
- Integrated water manifold
- Epoxy-coated cooler cavities
- Single-point water connection
- Designed in compliance with ASME

See Our Entire Centrifugal Portfolio

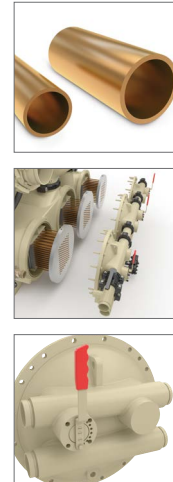
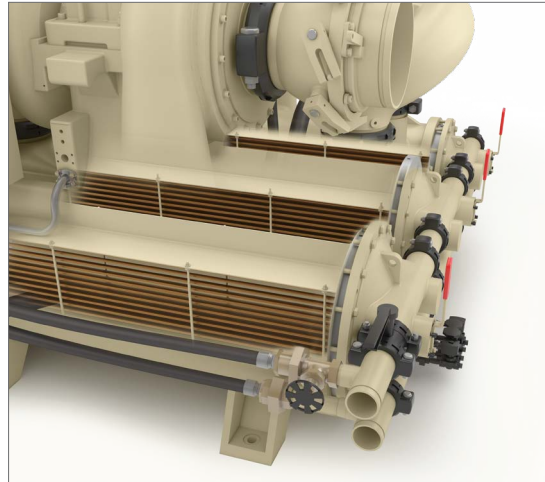

MSG TURBO-AIR NX 5000

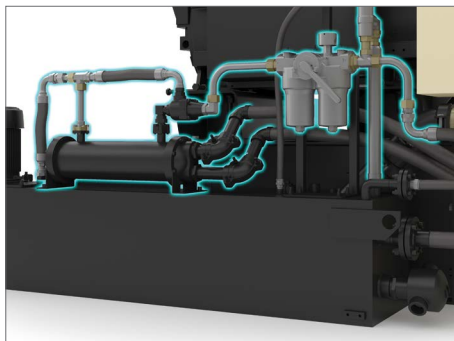

MSG TURBO-AIR NX 2500

Lubrication System

- Side-mounted lube oil reservoir with top-mounted components and access port ensures easy access for periodic inspection, maintenance and monitoring
- Duplex filters are included as standard for continuous, uninterrupted operation
- Lubricant piping/tubing designed with field tested connections to reliably eliminate oil leaks, even in harsh industrial environments

Condensate System

- Easy to access condensate connections
- Dual connections for each cooler section simplifies installation of the condensate bypass
- Optional pre-engineered and proven condensate trap systems provide peace of mind

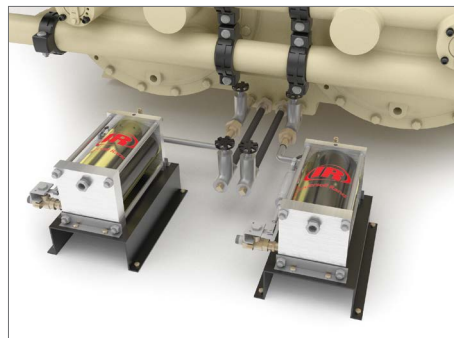

MSG TURBO-AIR NX 5000



MSG TURBO-AIR NX 2500



MSG TURBO-AIR NX 5000



MSG TURBO-AIR NX 8000

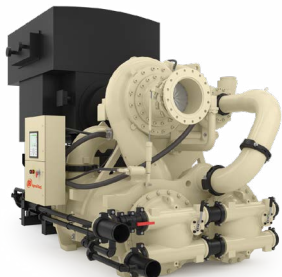

MSG TURBO-AIR NX 12000

MSG TURBO-AIR NX Features and Benefits

Efficiency

- Optimized compression elements and gas passages designed using computational fluid dynamics to ensure stable, high efficiency compressor operation
- Intercooler bundles optimized for superior heat transfer and low pressure drop to maximize compressor performance
- Variable inlet guide vanes offer up to 9% power savings when operating in turndown

Reliability

- Advanced pinion bearing design extends life and operation at any load
- OEM-optimized, cast-in-water manifold with optional patent-pending integral trim valves
- Non-wearing labyrinth air and oil seals provide continuous performance over the compressor's life without the need for periodic replacement
- Tilting pad or flexure pivot journal bearings (model specific) enhance mechanical reliability across the application range

Productivity

- Advanced design impellers provide efficient performance across a wide flow and pressure range
- Water-in-tube intercooler and aftercooler bundles slide out for easy inspection and cleaning as applicable
- Horizontally split gearbox provides easy access to core components for inspection and maintenance

MSG TURBO-AIR NX Performance

Model	Nominal Power kW (hp)	Discharge Pressure barg (psig)	Flow m ³ /min (cfm)
MSG TA-NX 2500	335-670 (450-900)	2.7-14.5 (39-210)	65-137 (2,300-4,800)
MSG TA-NX 5000	600-1,900 (800-2,500)	2.5-40 (35-585)	125-240 (4,500-8,600)
MSG TA-NX 8000	750-2,700 (1000-3,750)	2.5-40 (35-585)	135-310 (4,850-11,100)
MSG TA-NX 12000	1,100-4,200 (1,500-5,650)	3.5-40 (50-585)	210-525 (7,500-18,500)



MAINTENANCE SERVICES

Ensure reliability for the life of your compressed air equipment with our comprehensive maintenance programs. At Ingersoll Rand, we have one goal—to earn the right to be your trusted partner.



The CARE Service Program Advantage

Compressed air is critical to your operation. A proper maintenance strategy is crucial to avoiding unplanned, unbudgeted downtime and production interruptions. By choosing an Ingersoll Rand CARE service program, you are investing in your future with a trusted partner.

Depending on your rotary screw compressor system maintenance requirements, choose from one of these two programs. Each program includes genuine OEM parts that eliminate inferior performance caused by generic parts that will cost you more in the long run.

PackageCARE™ Total Protection, Eliminate the Risk



- Greatest value for asset management
- Transfer operational risk for up to 10 years
- Includes all scheduled maintenance
- Predictive and analytical tools prevent production interruptions

PlannedCARE™ Comprehensive Parts and Service Coverage



- Predictable, on-time planned maintenance
- Preventative diagnostics to catch potential problems
- Up to 5-year coverage on major airend components in new centrifugal compressors

Choose the Right Maintenance Program for You

IT ALL ADDS UP TO PEACE OF MIND



Lower Cost of Ownership

Our service programs provide the most cost-effective solutions based on your customized maintenance strategy.

Quality Results

Ingersoll Rand factory-trained service technicians are backed by more than 145 years of industry experience.

Increased Uptime

Service programs help decrease unplanned downtime and costly production interruptions.

Efficient Energy Use

Peak system efficiency is achieved through properly performed maintenance and inspection.

Peace of Mind

Our world-class services will help you achieve the results you need, while you focus on what's important to your business.

Remanufacturing Services

Replacing compressed air equipment can significantly impact your bottom line. Fortunately, Ingersoll Rand's remanufactured products can reduce that impact with an economic and environmentally sustainable alternative to new equipment.

Our qualified technicians have extensive knowledge and experience in parts restoration and remanufacturing of centrifugal air compressors, including:

- Compressor overhaul
- Compressor airend remanufacturing
- Remanufactured and engineered packages
- Performance re-rates
- Clean and dynamic balance of all rotating assemblies
- Cooler refurbishing



You will receive a 'like-new' piece of equipment while reducing equipment costs, downtime and energy usage...as well as taking advantage of the latest technology advances.



Air Treatment

Moisture and contamination in compressed air can cause significant problems in equipment operation, damage or shutdowns. Making air treatment equipment an integral component of your compressed air system will improve productivity, system efficiency and product or process quality.

Desiccant Dryers

Choose desiccant dryers when very low dew points are necessary for high-quality air and to prevent potential freeze-up, including heat-of-compression (HOC) dryers that minimize energy use.



- -40°C (-40°F) pressure dew point in most operating conditions
- High-strength desiccant and durable valves
- Low pressure drop design saves energy
- Intuitive microprocessor control maximizes uptime



Refrigerated Dryers

Cost-effective refrigerated dryers provide clean, dry air for most applications. Choose cycling dryers to maximize energy savings or non-cycling dryers for a lower initial cost.



- Dew points as low as 3°C (38°F) (Class 4)
- Corrosion-free heat exchanger design
- Intuitive microprocessor control for easy operation
- Compact design for easy serviceability



PARTS & ACCESSORIES

A compressed air system is a significant investment. You expect consistently reliable, clean, dry air at the lowest possible operating cost. Choose our genuine parts and accessories to ensure that your compressor is running efficiently and productively.

Control Systems

Advanced MAESTRO controls are the current standard for MSG TURBO-AIR compressors and are available as an upgrade for existing centrifugal compressor installations. We offer two distinct MAESTRO models, each designed for your specific compressor control needs.

MAESTRO UNIVERSAL



An advanced control system with web-enabled monitoring, MAESTRO UNIVERSAL provides a built-in web server for compressor monitoring using your local Intranet.

MAESTRO PLC

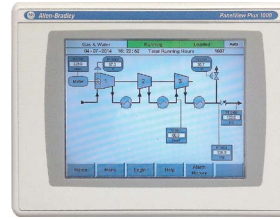

Utilizing an open architecture Allen-Bradley® PLC, MAESTRO PLC uses off-the-shelf components that better match other controls and best practices in your plant.

Protect Your Investment

Techtrol Gold TL is the only synthetic coolant formulated specifically for MSG TURBO-AIR centrifugal compressors.

Techtrol Gold TL Synthetic Coolant

Techtrol Gold TL is an engineered synthetic coolant specifically designed to help MSG TURBO-AIR NX centrifugal compressors maintain peak performance over a full range of operating temperatures, maximizing cost savings and reliability.

When compared to mineral-based lubricants, Techtrol Gold synthetic coolant offers significant advantages:

- Premium base stock provides exceptional performance, surpassing all mineral-based lubricants
- Extended operating life of three years (24,000 hours), reducing fluid disposal frequency and costs
- Eliminates deposits and build-up of debris caused by fluid breakdown allowing bearings to run cooler, minimizing downtime and costs
- Superior film strength protects against metal-to-metal contact
- Stable viscosity over a wide temperature range ensures optimized compressor performance and efficiency, even in varying environmental conditions and mechanical loads
- Exclusive blend formulated specifically for Ingersoll Rand centrifugal compressors that exceeds lubricant specifications to assure consistent quality

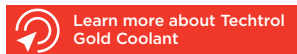



No-Loss Drains

Our electronic and pneumatic no-loss drains are the most reliable, durable and energy-efficient way to remove condensate from air compressors and a variety of other air system components.



Installation Solutions

From receiver tanks to couplings, our installation solutions offer everything you need to deliver clean, dry air from the compressor to your point of use.



OEM Replacement Parts

We have the exact genuine OEM parts you need—from a replacement bullgear to a missing bolt—with extensive inventories maintained in strategic locations around the world.



Filters

Our intake filtration systems remove particulates from the incoming air stream to preserve downstream filtration element life, as well as reducing energy costs.

 See All of Our Genuine OEM Parts and Accessories

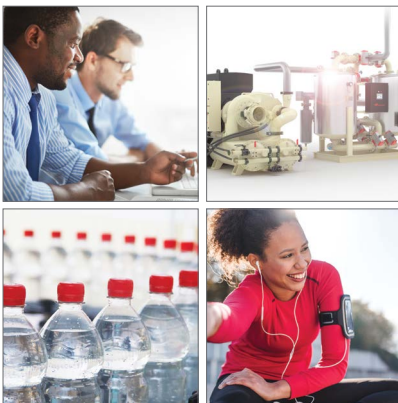

Custom Engineered to Your Requirements

Ingersoll Rand manufactures a full line of centrifugal compressors that can be specifically tailored to your exacting needs through our Engineered-To-Order (ETO) services. From expanded instrumentation with PLC control to increased protective equipment for aggressive environments, our comprehensive ETO services team will design a quality compressed air system through our robust processes and network of experienced professionals to ensure your peace of mind and a lower total cost of ownership.

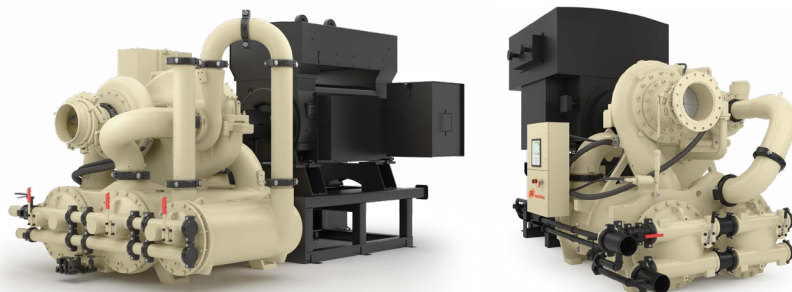



About Ingersoll Rand Inc.

Ingersoll Rand Inc. (NYSE:IR), driven by an entrepreneurial spirit and ownership mindset, is dedicated to helping make life better for our employees, customers and communities. Customers lean on us for our technology-driven excellence in mission-critical flow creation and industrial solutions across 40+ respected brands where our products and services excel in the most complex and harsh conditions. Our employees develop customers for life through their daily commitment to expertise, productivity and efficiency. For more information, visit www.IRco.com.

IngersollRand.com



Member of Pneurop



Ingersoll Rand, IR, the IR logo, MAESTRO, MSG, PackageCARE, PlannedCARE and TURBO-AIR are trademarks of Ingersoll Rand, its subsidiaries and/or affiliates. All other trademarks are the property of their respective owners.

Ingersoll Rand compressors are not designed, intended or approved for breathing air applications. Ingersoll Rand does not approve specialized equipment for breathing air applications and assumes no responsibility or liability for compressors used for breathing air service.

Nothing contained on these pages is intended to extend any warranty or representation, expressed or implied, regarding the product described herein. Any such warranties or other terms and conditions of sale of products shall be in accordance with Ingersoll Rand's standard terms and conditions of sale for such products, which are available upon request.

Product improvement is a continuing goal at Ingersoll Rand. Any designs, diagrams, pictures, photographs and specifications contained within this document are for representative purposes only and may include optional scope and/or functionality and are subject to change without notice or obligation.

We are committed to using environmentally conscious print practices.

© 2022 Ingersoll Rand IRITS-0820-029 0923