

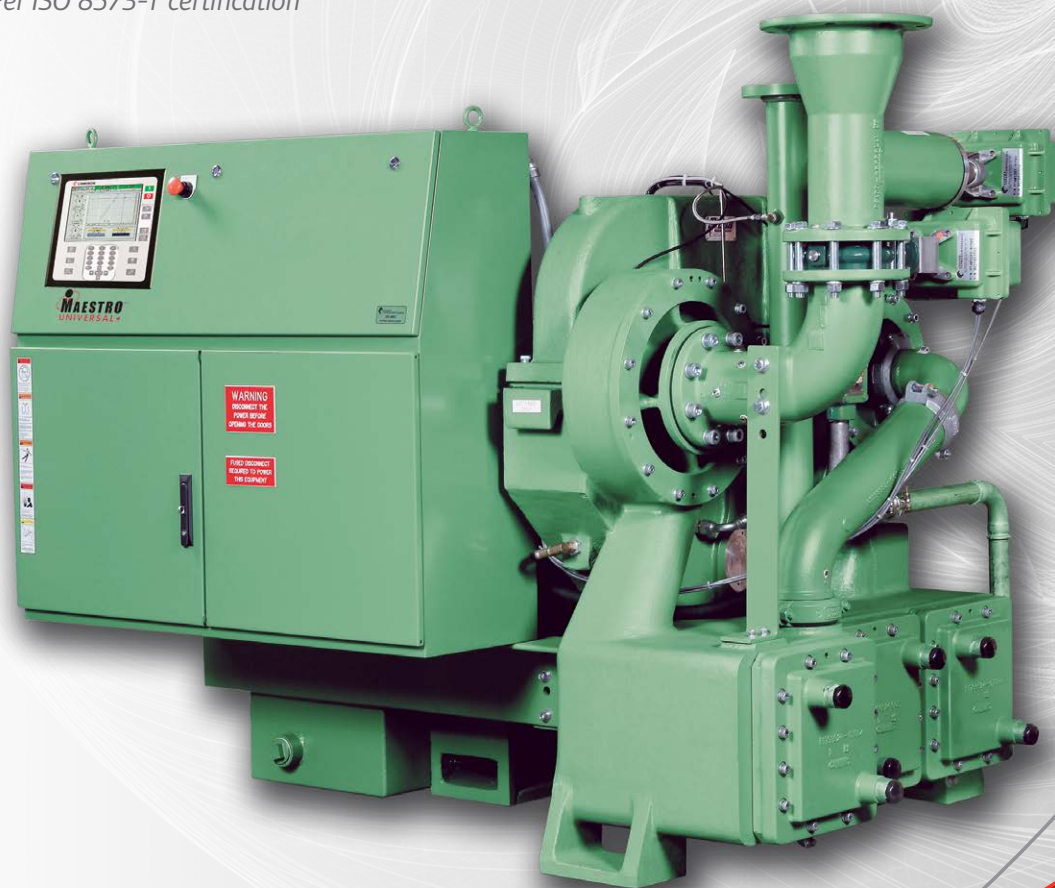

MSG[®] TURBO-AIR[®] 2000 Centrifugal Compressor

100% oil-free air*

**Per ISO 8573-1 certification*



Your Trusted Partner in Compressed Air

Ingersoll Rand works to keep you ahead of your competition with advanced compressed air systems that boost productivity, lower operating expenses and extend equipment life. These innovations are designed into every MSG® TURBO-AIR® compressor to optimize your total cost of ownership (TCO).

Take a Systems Approach

Optimizing TCO, and delivering reliable oil-free compressed air to your facility goes well beyond the compressor itself. To maximize your ROI, it's imperative to manage the entire lifecycle of a compressed air system, from installation to decommissioning or expansion.



Benefits of MSG TURBO-AIR Compressors

ISO 8573-1 CERTIFIED OIL-FREE AIR

- Prevents oil contamination of your system
- Limits the potential for compressed air pipeline fires caused by oil carryover
- Eliminates costly waste disposal problems associated with oil-laden condensate
- Eliminates the expense and associated maintenance requirements of oil-removal filters, since no oil enters the compressed air stream in the compressor

SIMPLE INSTALLATION

- True unloading capability helps to take advantage of opportunities for energy savings
- Increased uptime compared to alternative technologies translates into reduced operating life-cycle costs
- Reduced number of external connections
- Compact design reduces required floor space
- Meets OSHA's sound level requirements without sound enclosure

LOW-COST OPERATION

- True unloading capability; energy savings and increased uptime translate to reduced operating life-cycle costs
- Excellent part-load efficiencies for any operating load
- No sliding or rubbing parts in the compression process causing wear or efficiency loss

EASY OPERATION

- The MAESTRO™ Universal control panel provides a built-in web server, allowing compressor monitoring using your local intranet
- Significant annual savings in operating cost by providing more precise control
- Easy-to-use, automatic operation

EASY MAINTENANCE

- Compression elements do not wear or require periodic replacement
- No oil-removal filters to clean or replace
- Accessible, horizontally split gearbox for quick inspection
- Intercooler and aftercooler bundles are easy to remove for inspection and cleaning
- Water-in-tube design intercooler and aftercooler allow for simple mechanical cleaning
- Maintenance-free dry coupling

HIGH RELIABILITY

- Thrust loads absorbed at low speed
- Non-contacting air and oil seals
- Stainless steel compression elements
- Conservative, high-quality gear design
- Extended life pinion bearing design
- Centrifugal compressors are proven to have a long mean time between failures (MTBF), and independent research has shown an industry-leading availability of 99.7%

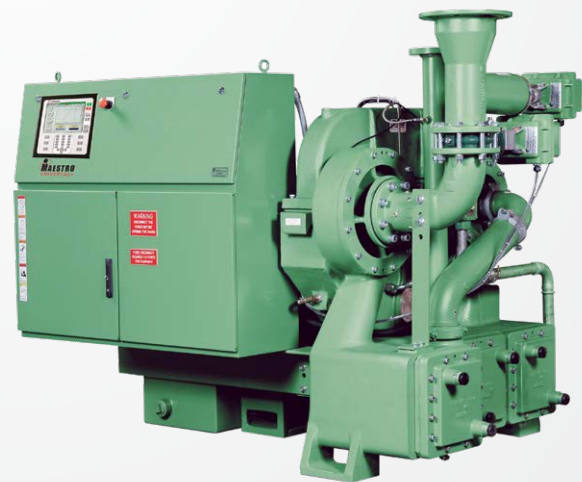

MSG TURBO-AIR 2000 Centrifugal Compressors

EFFICIENT PACKAGE

MSG TURBO-AIR 2000 compressors feature easy, low-cost installation and operation. They include a control center, built-in aftercooler and packaged check valve.

Compressor Motor Sizes Available

93 to 260 kW (125 to 350 hp)

Compressor Discharge Pressure Ranges

3.5 to 10.3 barg (50 to 150 psig)

Compressor Flow Ranges

14.3 to 48.1 m³/min (505 to 1700 cfm)

Typical Package Weight*

3400 kg (7500 lb) *driver dependent

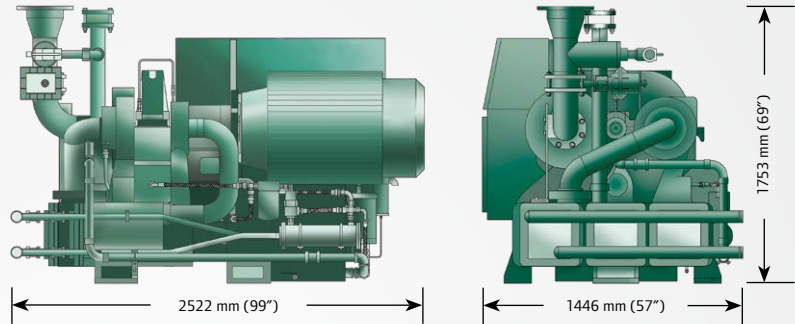

TYPICAL PERFORMANCE CURVE FOR 224 KW (300 HP) / 8.6 BARG (125 PSIG)

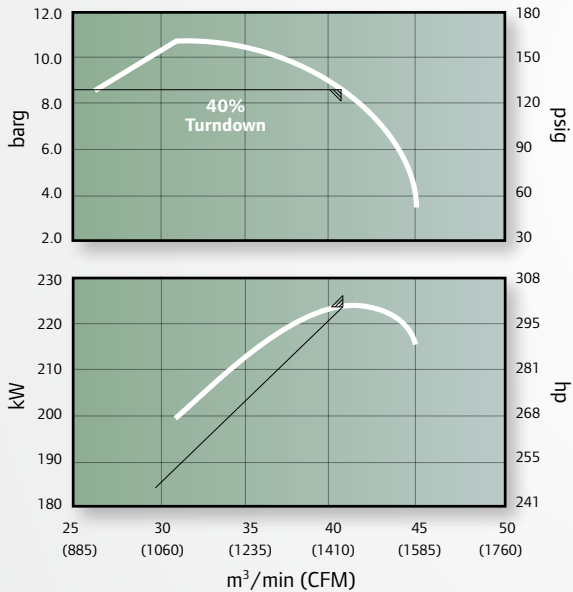

Impellers

Advanced design combines the best features of a semi-radial, backward-leaning impeller.



Vaned Diffusers

Matching diffusers are used for increased efficiency.

TYPICAL P&ID

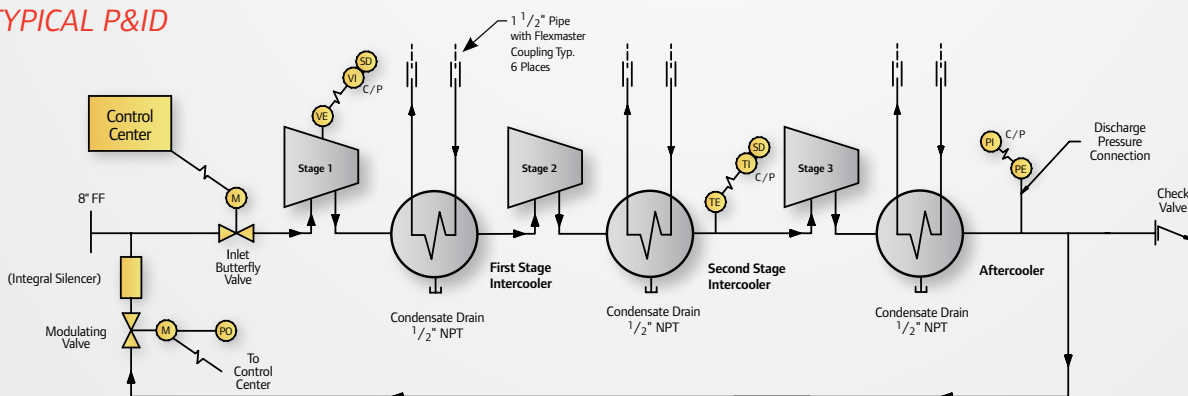

LOW TOTAL COST OF OWNERSHIP

Over time, the energy required to power a compressed air system is the largest cost associated with a compressor; particularly in today's fluctuating energy markets. That is why, to accurately determine the return on your investment, it is important to consider the total life-cycle cost of operating the compressor, including the initial investment, energy consumption and maintenance costs.

As the chart to the right demonstrates, the MSG TURBO-AIR 2000 compressor provides some of the lowest total life-cycle costs of any compressor, including dry screw, variable speed drive (VSD) screw and other centrifugal compressors.

Compared to other machines of similar capacity, MSG TURBO-AIR 2000 compressors are one of the most efficient oil-free compressors at full load, part load and no load.

The power savings delivered can significantly speed up the payback on your initial investment, and the savings continue to build the more you use the MSG TURBO-AIR 2000 compressor.

Life-Cycle Cost Comparison

(over 10 years of operation at 80% loaded)

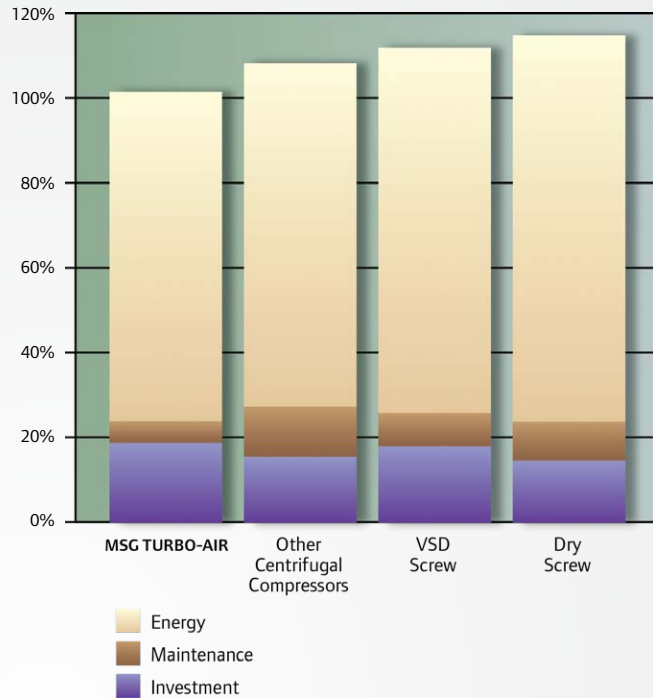

LUBRICATION SYSTEM DIAGRAM

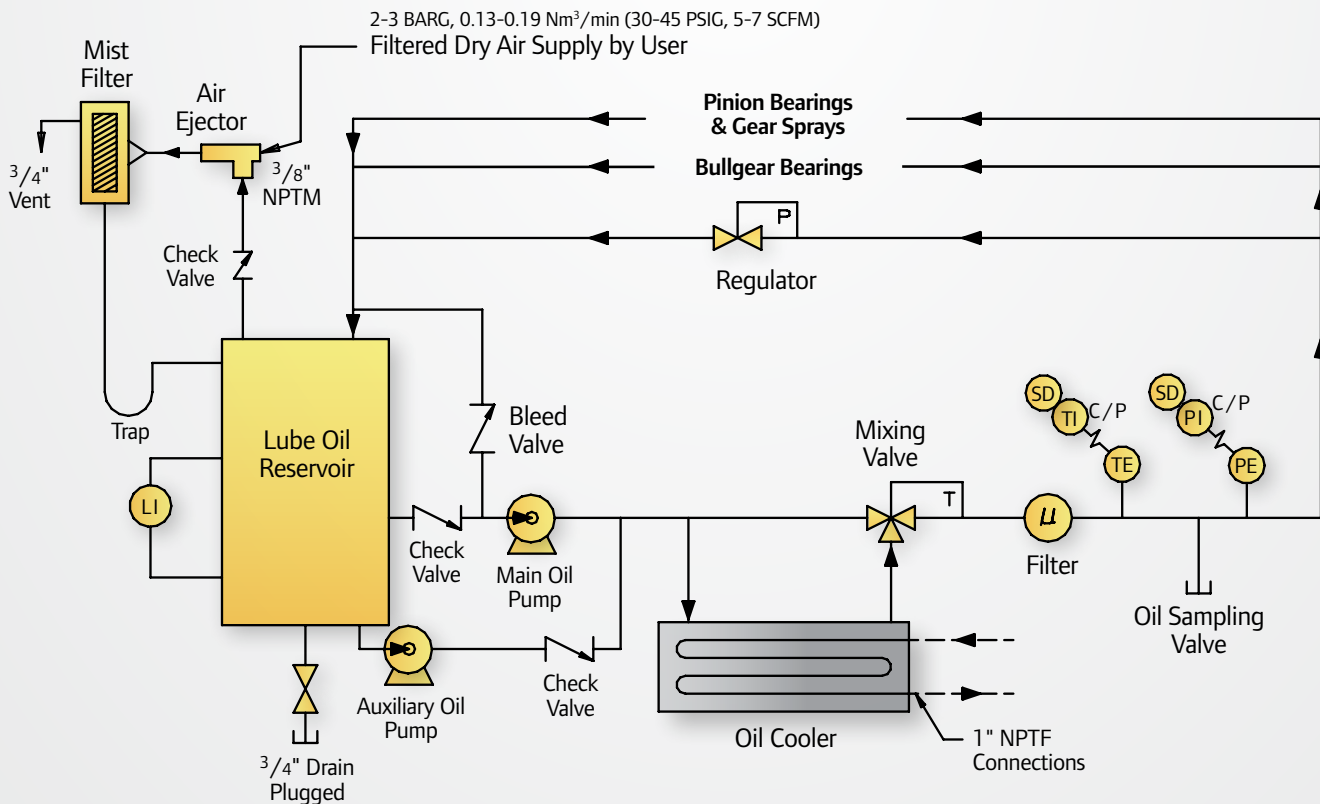

BEARINGS AND SEALS



Superior Pinion Bearing Design

For extended life and operation at any load. Patented, hydrostatic-squeeze-film design.

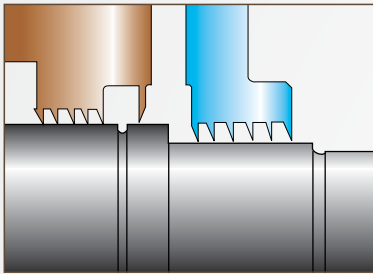

Seals

Non-contacting, non-wearing labyrinth air and oil seals, with atmospheric air gap, require no buffer air for oil-free air, and eliminates the need for periodic replacement of carbon-ring seals and instrument air for permissive starting.

LUBRICATION SYSTEM



All MSG TURBO-AIR compressors feature a self-contained, low pressure lubrication system.

INTERCOOLERS AND AFTERCOOLERS

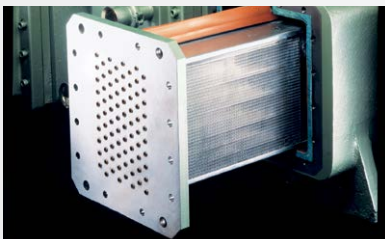

Water-in-tube intercooler and aftercooler bundles slide out for easy inspection and cleaning.

CONTROL SYSTEMS

Ingersoll Rand can provide the right control system engineered for your applications.

MAESTRO Suite of Controls

MAESTRO control systems offer optimal protection and control for your compressed air system. The MAESTRO suite contains a model that is sure to be in tune with your needs.

MAESTRO Universal

- Windows CE-driven system includes a built-in web server and setup wizard for quick configuration
- Able to handle multiple stages and designed for many makes and models of compressors
- 10" color graphic display provides easy monitoring
- Built-in USB port for system configuration and data logging
- Capable of monitoring and controlling the total system across multiple units



MAESTRO PLC

- Utilizes an Allen-Bradley CompactLogix platform with: 16 digital inputs, 16 digital outputs, 16 analog inputs, 4 analog outputs and 12 RTD inputs
- Comes standard with an Allen-Bradley PanelView Plus 1000 10" touchscreen
- Networking software available for automation of multiple units and total system automation
- Optional stainless steel enclosure available

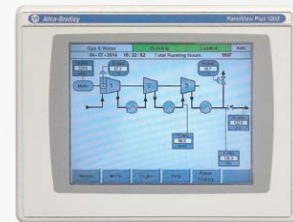

ISO CERTIFIED CLASS ZERO





The MSG TURBO-AIR centrifugal compressor product line has been engineered to produce oil-free air for over 60 years. This certification officially acknowledges the ability of our compressors to produce 100% oil-free air, providing our customers with enhanced quality assurance.



Centrifugal Aftermarket Parts and Services

Count on Ingersoll Rand for genuine parts and comprehensive services for our centrifugal compressed air systems. Here are just a few comparisons of our industry-leading aftermarket support.

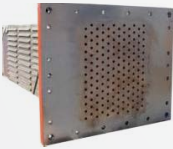
Ingersoll Rand vs. the Competition

AIR FILTRATION	Ingersoll Rand	Competitors
	Micro-fiberglass media, high removal efficiency	Paper media, poor removal efficiency
	2" deep pre-filter has more filtration area	1.5" deep pre-filter is inferior
	3,000 cfm capacity per panel	2,500 cfm capacity per panel
	0.42 inches w.g. clean pressure drop	0.7 inches w.g. clean pressure drop
OIL FILTRATION		
	Micro-fiberglass media, high removal efficiency	Paper media, poor removal efficiency
	Extra micro-glass filtration layer	Only one filtration layer
	Diffuser and support layer	No diffuser and support layer
	Aerospace technology for jet turbines	Garage quality parts
LUBRICATION		
	Proprietary additives for peak performance	Generic additives shrink performance
	API Group II oil does not form varnish	API Group I oils form varnish
	Special blend does not dissolve seals	Incompatible blends dissolve seals
	Longer life for extended change intervals	Shorter life increases maintenance costs
COOLERS		
	Designed for maximum heat transfer area	Smaller heat transfer area
	Design ensures correct temperatures	Increased discharge temperatures
	Heavy duty baffle assembly lasts	Thin baffles break easily
	Seals made from high temperature materials	Seals made from inferior materials
SERVICE & REPAIRS		
	Full mechanical and aerospace testing capability	No testing for capability
	OEM design and manufacturing expertise	No access to drawings or tolerances
	OEM parts designed for high performance	Imitation parts can damage machine
	Database of repair and maintenance activity	No machine history intelligence



Ingersoll Rand (NYSE:IR) advances the quality of life by creating comfortable, sustainable and efficient environments. Our people and our family of brands—including Club Car®, Ingersoll Rand®, Thermo King® and Trane®—work together to enhance the quality and comfort of air in homes and buildings; transport and protect food and perishables; and increase industrial productivity and efficiency. We are a \$14 billion global business committed to a world of sustainable progress and enduring results. For more information, visit www.ingersollrand.com.



IngersollRandProducts.com



Ingersoll Rand, IR the IR Logo, MSG TURBO-AIR, and MAESTRO are trademarks of Ingersoll Rand, its subsidiaries and/or affiliates. All other trademarks are the property of their respective owners.

Nothing contained on these pages is intended to extend any warranty or representation, expressed or implied, regarding the product described herein. Any such warranties or other terms and conditions of sale of products shall be in accordance with Ingersoll Rand's standard terms and conditions of sale for such products, which are available upon request.

Product improvement is a continuing goal at Ingersoll Rand. Any designs, diagrams, pictures, photographs and specifications contained within this document are for representative purposes only and may include optional scope and/or functionality and are subject to change without notice or obligation.