



MSG[®] Centrifugal Process Gas Solutions



Your Trusted Partner in Compressed Gas

Efficient operation of your process gas facility relies heavily on an advanced compressed gas system that boosts productivity, lowers operating expenses and extends equipment life. No matter the industry or application, you can count on Ingersoll Rand® as a trusted partner for centrifugal gas compression technologies and services for superior performance.

Take a Systems Approach

Delivering reliable compressed gas to your process goes well beyond the compressor itself. To maximize performance, it is imperative to manage the entire lifecycle of your compressed gas system.

Your system can be optimized at many points—from design to operation to overhaul. Your operation will benefit from Ingersoll Rand's partnership through our extensive experience and global expertise to ensure reliability, lower maintenance costs and ease of service.



Let's Get Started Together
Ingersoll Rand Contracting Services Video





A History of Innovation

- 1955 Joy Manufacturing Co. established facility in Buffalo, N.Y.
- 1960 First small integrally geared centrifugal compressor introduced
- 1965 First commercial centrifugal compressor package
- 1971 First four-stage, nitrogen recycling machine for liquefaction of industrial gases
- 1980 First microprocessor-controlled compressor launched
- 1987 Cooper Industries Inc. purchases Joy Manufacturing Co.
- 1988 First seven-stage, dual-service machine with three pinons in each gearbox
- 1994 TURBO-AIR® 2000 introduced, incorporating the fourth generation of microprocessor-based controls
- 1995 Cooper Cameron Corporation established
- 1997 TURBO-AIR 3000 introduced
- 1999 TURBO-AIR 6000 introduced
- 2001 First natural gas compressor delivered
- 2002 Cooper Energy Services and Cooper Turbocompressor combine to form Cooper Compression
- 2004 MAESTRO™ series of control systems introduced
First CO₂ gas compressor delivered
- 2005 First mixed-refrigerant compressor for LNG liquefaction
MSG® and TURBO-AIR compressor manufacturing begins in China
- 2006 Company name changed to Cameron
First hydrogen compressor delivered
- 2008 TURBO-AIR high pressure series introduced with TURBO-AIR 2040
First CO compressor for HyCO process application delivered
- 2009 MSG-18 introduced
ISO 8573-1 Class Zero Certification awarded
- 2010 MSG TURBO-AIR 6040 introduced
- 2012 200th process gas compressor delivered
- 2013 MSG TURBO-AIR NX 12000 introduced
First propylene compressor delivered
- 2015 Ingersoll Rand acquires Cameron's Centrifugal Compression division
TURBO-AIR production in China moved to Wujiang campus
- 2016 TURBO-AIR NX 8000 introduced
- 2019 Grand opening of state-of-the-art MSG production and test laboratory facility at Wujiang
- 2020 Ingersoll Rand's industrial business segment and Gardner Denver merge, retaining the Ingersoll Rand name



MSG Integrally Geared Centrifugal Compressors

Compare the innovative centrifugal compressor technology of the MSG with other compressors, and the advantages are clear.

MSG CENTRIFUGAL COMPRESSORS	OTHER COMPRESSORS
 <p>LOW MAINTENANCE</p> <ul style="list-style-type: none"> • Compression elements don't require periodic replacement • Accessible horizontally split gearbox for quick inspection • Removable intercooler and aftercooler bundles for easy cleaning • Oil and seal gas filter elements are easily replaced online 	<ul style="list-style-type: none"> • Require regular maintenance, such as replacement of piston rings, gland packing and valve plates, or periodic replacement of air ends • Result in high operating expenses and significant machine downtime
 <p>OIL-FREE GAS</p> <ul style="list-style-type: none"> • 100% oil-free per ISO 8573-1 certification • Prevents system contamination • No costly waste disposal associated with oil-laden condensate • Eliminates the expense and maintenance of oil separation filters at the discharge 	<ul style="list-style-type: none"> • Oil filters must be installed at discharge • Potential for oil carryover to foul the process • Oil free claim is based dependent on uninterrupted seal gas supply
 <p>RELIABILITY</p> <ul style="list-style-type: none"> • Centrifugal compressors have industry leading 99.7% MTBF • Conservative high-quality gear design and stainless steel compression elements • Long-life pinion bearing design • Highly resilient to surge events 	<ul style="list-style-type: none"> • Contacting compression elements are subject to wear • Limited rotating element life • Designed-in wearing items to generate aftermarket revenues • Require costly surge control systems to avoid damage to seals and bearings
 <p>OPTIMUM CONTROL</p> <ul style="list-style-type: none"> • Inlet guide vane control and bypass for consistent gas delivery • Automatic operation and precision control for most operating conditions • State-of-the-art MAESTRO-suite of controls • PLC control systems available 	<ul style="list-style-type: none"> • Expensive, variable-frequency controls may be required to adjust capacity • Cylinder unloading for stepped flow control can result in complicated process control due to sudden changes in capacity
 <p>COMPACT INSTALLATION FOOTPRINT</p> <ul style="list-style-type: none"> • Single-lift skid or flexible modules • Easy installation with no special foundation requirements • Reduced floor space, easy component accessibility • Site connection point flexibility • Dynamic compression is pulsation-free • Essentially vibration-free 	<ul style="list-style-type: none"> • Require additional, external speed-changing gearbox for drivetrain input. • Use of large pulsation dampers to reduce pressure fluctuations • Multiple cylinders require more space for installation • Require large and deep foundation to handle heavy weight and unbalanced forces • Precautions must be taken to prevent transmission of vibration to other equipment

Low Compressor Operating Lifecycle Cost

- Excellent efficiencies at full load, part load and no load
- Low maintenance cost
- Increased uptime from high-reliability design
- No sliding or rubbing parts in the compression process that can cause wear and efficiency loss

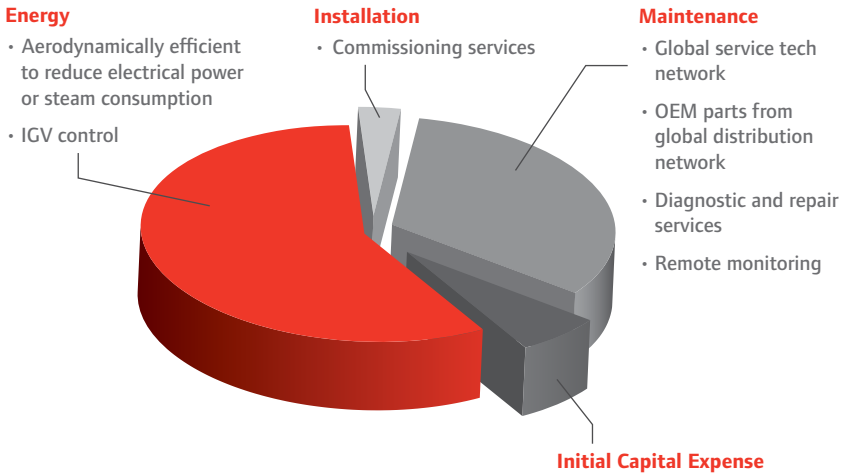



MSG COMPRESSOR APPLICATIONS

PROCESS GAS APPLICATIONS

We offer a broad portfolio of reliable centrifugal products that is designed to meet the requirements of your process gas application. With more than 40,000 centrifugal installations worldwide, on every continent, Ingersoll Rand's products are proven in a number of different applications.

Natural Gas Processing Plant

Raw natural gas undergoes a number of purification processes before being pressurized and sent to a pipeline.

NGL Fractionation

Fractionation is the process of separating extracted NGL compounds (ethane, propane, butane) from the natural gas stream to be sold as commodities.

LNG Liquefaction

During the LNG refrigeration process, natural gas is liquefied to approximately 1/600th of its volume, allowing it to be transported more efficiently and economically.

Fuel Gas Boosting

For natural gas-fired power plants, fuel gas boosters are used to raise the natural gas pressure from the pipeline to the required pressure of the gas turbine.

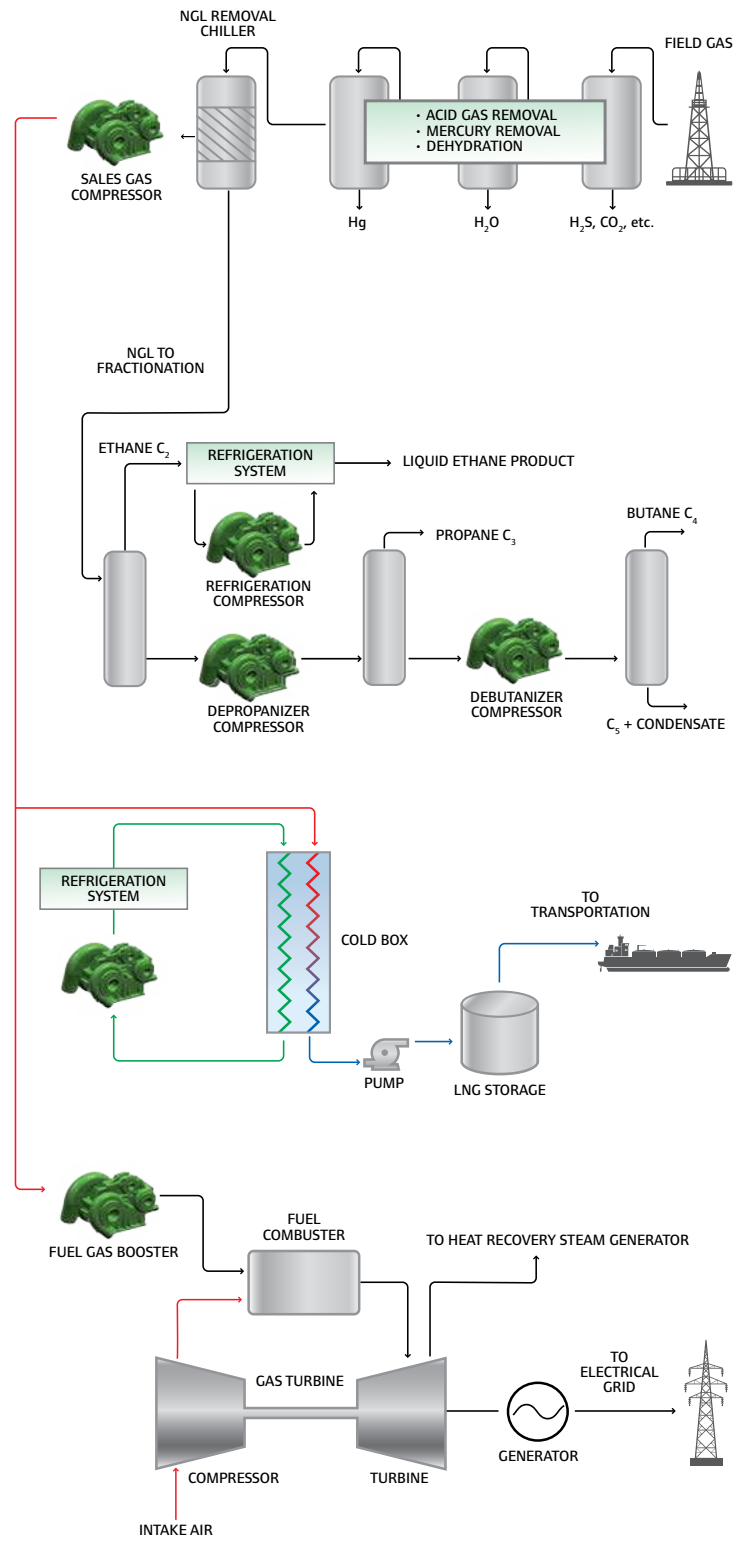

Experience that Delivers Results

Ingersoll Rand has a profound understanding of the most challenging application requirements. We build on our broad experience to design and deliver the best process gas compressor solution for your specific needs. Here are two typical applications of MSG process gas compressors.

Refrigeration

Pure or mixed refrigerant gases are used in a variety of industries for applications such as gas liquefaction and process chilling. In all refrigeration systems, the gas compressor is the heart of the refrigeration cycle.

A dynamic compressor operating at peak efficiency with varying operating cases is vital to optimize a refrigeration system. MSG integrally geared centrifugal compressors can optimize the efficiency of each compression stage by matching the impeller speed and geometry to the required aerodynamic parameters. A number of seal options that minimize the loss of valuable refrigerant and ensure zero atmospheric leakage are available.

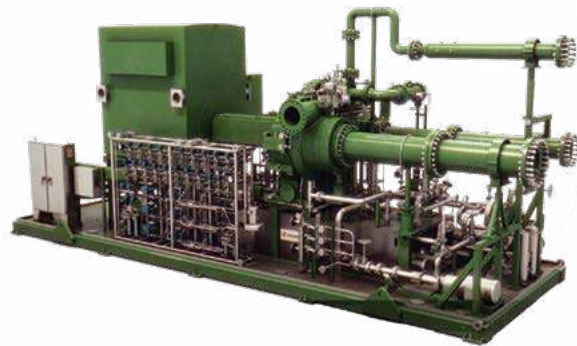

Fuel Gas Boosting

In gas fired power plants, the fuel gas booster compresses natural gas from a pipeline to maintain a consistent fuel supply to the gas turbine. Ingersoll Rand leverages its extensive experience to design robust packages that ensure the highest reliability, and avoid damaging turbine trips. Both our custom and standard packages facilitate installation, while meeting applicable industry standards.

MSG FEATURES AND BENEFITS

With experienced design teams and numerous available configurations, our MSG compressors are application engineered to deliver the performance and quality you need.



MSG CENTRIFUGAL COMPRESSORS

The Right Compressor for Your Application

MSG compressors for process gas applications are engineered with numerous available configurations, offering outstanding design flexibility.



View Products
See our entire portfolio of process gas compressors

Oil-free Gas

- Prevents system contamination
- Reduces pipeline fire potential caused by oil carryover
- No costly waste disposal associated with oil-laden condensate
- Eliminates the expense of oil separation filters



High Reliability

- Conservative high-quality gear design
- Long-life pinion and bull gear bearing design
- Thrust loads absorbed at low speed
- Stainless steel compression elements



Low Lifecycle Cost

- Multiple process gas streams handled by a single compressor
- Excellent efficiencies at full load, part load and no load
- Low maintenance design
- No sliding or rubbing parts in the compression process



Easy Operation/Maintenance

- Horizontally split gearbox for quick inspection
- State-of-the-art MAESTRO control systems
- Automated operation for any process condition
- Machine self-diagnostics
- Removable intercooler and aftercooler bundles



Simple Installation

- Common base or flexible modules
- No special foundation requirements
- Easy component accessibility
- Site connection point flexibility
- Reduced floor space required

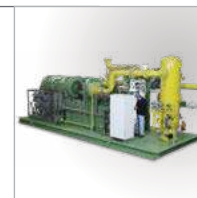

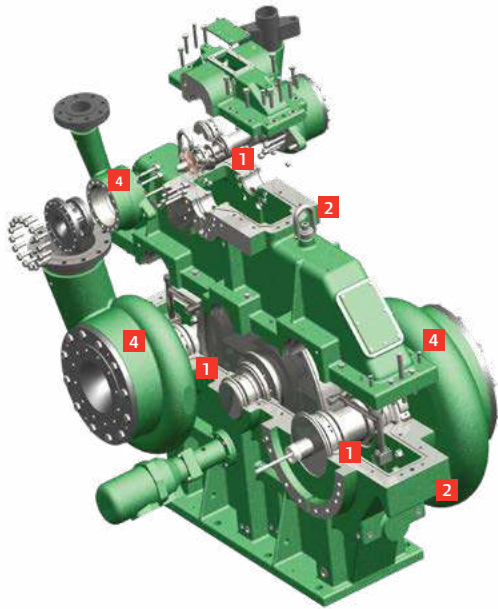

Optimized Efficiencies

Multiple independent compression stages, individual pinion gear selection and volute sizing options optimize material costs and compressor performance

Cross-sectional View of a Typical Three-rotor Process Gas Compressor

- 1 One, two or three rotors, up to six stages per gearbox
- 2 Horizontal splitline(s) for easy access to parts
- 3 Engineered seal designs
- 4 NACE-compliant scrolls and inlets can be manufactured from steel or stainless steel

Efficient Gas Flow

MSG centrifugal compressors feature an advanced arrangement of gas flow components. Advantages of this arrangement include:

- Directed gas movement to reduce turbulence induced friction
- Intercooling is possible after every stage to provide high isothermal efficiency

Gas Flow Diagram

- 1 Compressor inlet
- 2 First-stage compressor volute
- 3 Coolant in
- 4 Coolant out
- 5 First-stage intercooler
- 6 Second-stage compressor volute
- 7 Second-stage intercooler
- 8 Third-stage compressor volute
- 9 Compressor discharge

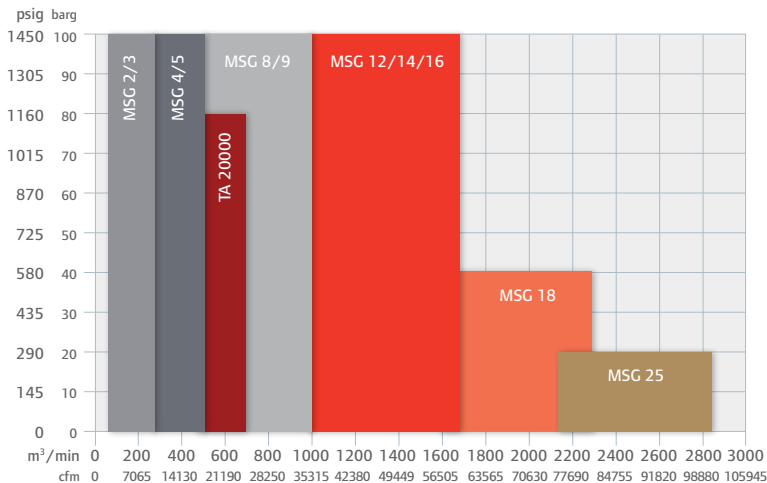
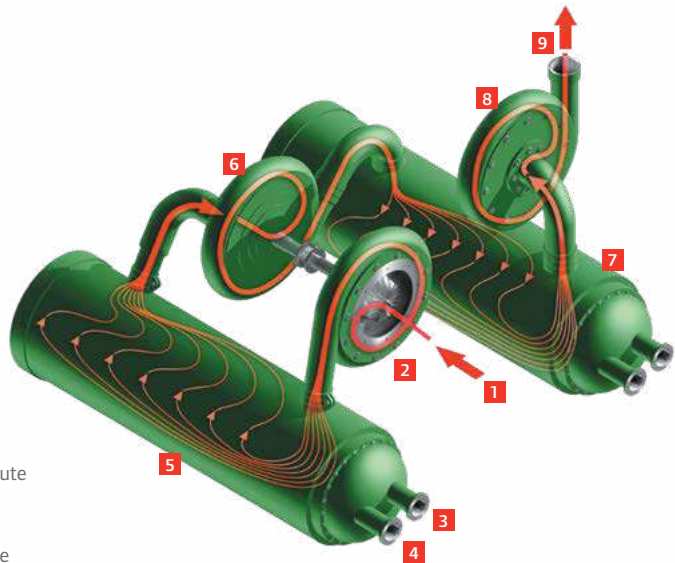

MSG Performance Ranges

MSG compressors can be custom engineered to meet a broad range of pressure and flow process conditions. The chart to the left details the coverage of our specific MSG models.

Integrally geared centrifugal (IGC) compressors represent the latest technology, offering significant advantages over outdated, less efficient and more costly compressor designs. These advantages are inherent in the centrifugal design and are further enhanced by Ingersoll Rand's more than 60 years of centrifugal expertise.

Compressor Core Design

MSG centrifugal compressors are exceptional by design. The core of the compressor represents the latest in techniques to optimize reliability and efficiency.

- One, two or three rotors, up to six stages per gearbox
- Horizontal splitline(s) for easy access to parts
- Bullgears for optimum speed and efficiency
- High reliability tilting pad pinion bearings
- Rotor assembly designed for smooth operation
- Durable tapered rider ring on pinion shaft thrust collars reduces power losses

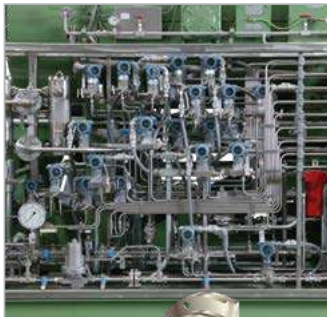

Gas Seal Support Systems

Gas seal support systems are designed, built and tested per API 614 or API 692. System designs can be based on differential pressure control, flow control or other control methods. The scope of supply is virtually unlimited.

- Designed with instrumentation to monitor seal condition
- API 692, API 614, or customer-specified systems can be engineered for most gas seal types
- Modular seal support system designs available for a wide range of requirements
- Use any seal type based on your process
- Filters and accessories supplied with sufficient instruments to plan maintenance and reduce downtime

Process Heat Exchangers

Our ASME-coded intercoolers (PED, China Code Pressure Vessel Certification, TR CU, KOSHA, and others, as required) provide efficient cooling between stages and are designed to be accessible for inspection and cleaning.

- Water-in-tube or gas-in tube available to suit the process application
- Available extended-surface, plate-fin design provides increased heat transfer with reduced space requirements
- Accessible, smooth-bore tubes are easily rodded with bundles in place
- No disassembly of any other part of the compressor is necessary to perform maintenance
- Custom materials of construction available to suit any gas composition





Lubrication System

Ingersoll Rand's standard self-contained, low pressure lubrication system is designed with all the necessary components for safe and efficient compressor operation. This includes an oil reservoir, shaft-driven main oil pump, electric full-flow auxiliary oil pump, fixed or removable-bundle oil coolers, dual full-flow oil filters and instrumentation. Features include:

- Welded interconnecting piping in carbon steel or stainless steel
- Assembled and packaged on a compressor base when compressor layout permits
- Can be designed to meet customer or industry specifications such as API 672, API 617, API 614 and Process Industry Procedures (PIP)
- Sized to serve the main drive
- Uses Techtrol Gold TL lubricant specifically formulated for centrifugal compressors to maintain peak performance and protection of critical components



Customized PLC-based Controls

PLC-based systems are used for packages with high input/output (I/O) counts, multiple gas circuit control loops and multiple processes. PLCs by all major suppliers are available. Ingersoll Rand can design, program and supply your specified PLC system mounted and wired to any compressor package.

- Fully tested before shipping
- Logic diagrams and programming software standard
- Locally mounted on skid, designed with local I/O and remote processors, or any buyer-defined arrangement
- Enclosures and wiring are available for US and IEC applications, Class 2/Zone 2 and non-hazardous installations
- Fully redundant PLC solutions available



Be in Control
See our portfolio of compressor accessories



Comprehensive Testing

To guarantee performance, MSG compressor designs are tested for aerodynamic and mechanical performance. Our flexible test stand uses variable speed drives to simulate various mole weight applications. All gas compressors are tested in accordance to ASME PTC-10 Type II standards. Test observation is available upon request. A full set of mechanical and aerodynamic performance data also can be provided.



AFTERMARKET SERVICES

AFTERMARKET SERVICES

How else can we prove our commitment to your total satisfaction? By providing the industry’s most comprehensive resource for top-notch aftermarket products and field service. Ingersoll Rand’s extensive network of highly skilled technicians and authorized representatives is at your service at over 80 locations worldwide.

Field Service

Ingersoll Rand’s field service team offers the expertise and skills required to ensure proper compressor operation and process integration. Our field service technicians are trained experts specialized in the technical coordination of on-site compressor services, including:

- Installation
- Startups
- Vibration analysis
- Turnaround inspections
- Field balancing
- Drive motor alignment
- Control system services
- Performance evaluation
- Preventative maintenance
- Diagnostic checks



A field service technician evaluates instrument readings on a 5-stage MSG-3 carbon monoxide compressor.



Learn More
Find out about our field service capabilities

Global Service Centers

Servicing centrifugal compressors requires high levels of expertise and precision to maintain tight manufacturing tolerances and ensure compressor performance. Ingersoll Rand has the facilities, equipment and experience strategically located throughout the globe to provide a complete range of services from simple parts inspections to complete compressor overhauls.

Benefits of Our OEM Service Centers

- Over 60 years of knowledge and expertise
- Access to original design specifications
- Complete service history to ensure accuracy
- In-house rework performed with proper equipment
- Genuine OEM replacement parts
- Full mechanical and aerodynamic testing capabilities
- Globally located - Davidson, NC, US; Milan, Italy; Ahmedabad, India; Shanghai, China





AFTERMARKET SERVICES

Whether your compression requirements have changed, or you are looking for increased efficiency, Ingersoll Rand offers a variety of performance-enhancing solutions that can improve operating efficiency.

Performance Enhancing Upgrades

Aerodynamic Modifications

As plant processes or job site locations change, so do process gas requirements. Ingersoll Rand offers a variety of aerodynamic modifications to adjust your existing performance to meet current process gas demands with optimal operating efficiency. These include re-rates to meet higher or lower pressure/flow requirements, airend upgrades for greater turndown range and increased rise to surge, as well as our custom 5-axis milled impellers that can provide improved performance.

Additional Upgrades

- **Duplex Oil Filters** - Simplify maintenance and maximize uptime with on-the-fly filter replacement
- **Duplex Oil Coolers** - Keep your compressor running during routine oil cooler maintenance
- **Control Valves** - Improve control precision with stepper motor and modulating blow-off valve technology
- **Cooler Bundles** - Improve performance or guard against corrosion with a variety of material and coating options

Inlet Guide Vanes

Our innovative inlet guide vanes (IGV) replace conventional inlet butterfly valves (IBV) with substantial potential for energy savings (up to 9%). This allows the compressor to take advantage of opportunities for energy savings when reduced flow is permitted or on days when the ambient conditions are favorable versus the design point.

OEM Replacement Parts & Accessories

As the OEM for MSG compressors, Ingersoll Rand can provide exact replacement parts for your maintenance and service requirements. We've got you covered for everything from a replacement bullgear to a missing bolt. We've maintained detailed records for every compressor we have ever built since the day it was delivered. We also maintain extensive inventories in strategic locations around the world backed by our OEM guarantee.

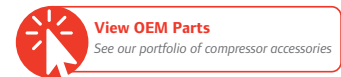

Excellence in Engineering

Maximize your total cost of ownership with Ingersoll Rand's extensive knowledge of compressor system design, applications, technologies and services—**we are your trusted partner in process gas systems.**





About Ingersoll Rand Inc.

Ingersoll Rand Inc. (NYSE:IR), driven by an entrepreneurial spirit and ownership mindset, is dedicated to helping make life better for our employees, customers and communities. Customers lean on us for our technology-driven excellence in mission-critical flow creation and industrial solutions across 40+ respected brands where our products and services excel in the most complex and harsh conditions. Our employees develop customers for life through their daily commitment to expertise, productivity and efficiency. For more information, visit www.IRco.com.

IngersollRand.com



Member of Pneurop



Ingersoll Rand, IR, the IR logo, MAESTRO, MSG and MSG TURBO-AIR are trademarks of Ingersoll Rand, its subsidiaries and/or affiliates. All other trademarks are the property of their respective owners.

Ingersoll Rand compressors are not designed, intended or approved for breathing air applications. Ingersoll Rand does not approve specialised equipment for breathing air applications and assumes no responsibility or liability for compressors used for breathing air service.

Nothing contained on these pages is intended to extend any warranty or representation, expressed or implied, regarding the product described herein. Any such warranties or other terms and conditions of sale of products shall be in accordance with Ingersoll Rand's standard terms and conditions of sale for such products, which are available upon request.

Product improvement is a continuing goal at Ingersoll Rand. Any designs, diagrams, pictures, photographs and specifications contained within this document are for representative purposes only and may include optional scope and/or functionality and are subject to change without notice or obligation.